

N2 package: 1200V 40A IGBT PIM module

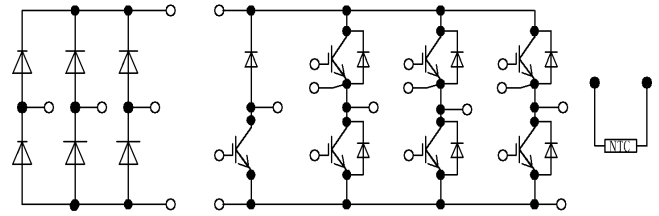
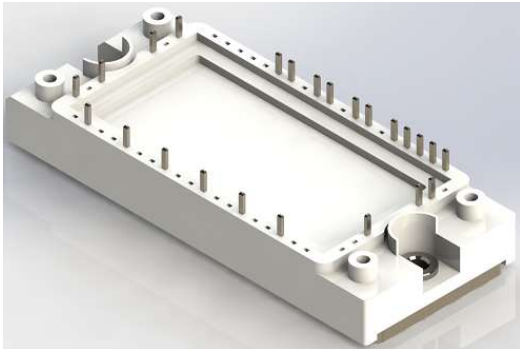

等效电路图

Equivalent Circuit Schematic

Features:

- 1200V 40A, $V_{CE(sat)} = 2.00V$
- High RBSOA capability
- High speed trench field-stop IGBT
- Low turn-off losses
- High short circuit capability

产品特性:

- 1200V 40A, $V_{CE(sat)} = 2.00V$
- 高 RBSOA 性能
- 沟槽栅场截止型 IGBT 芯片
- 低关断损耗
- 高短路耐量

Typical Applications:

- Motor Drives
- Servo drives

典型应用:

- 马达驱动
- 伺服驱动器

IGBT, Inverter / IGBT, 逆变部分

Maximum Rated Values / 最大标称参数

Collector-emitter Voltage 集电极-发射极电压	$T_{vj}=25^{\circ}\text{C}$	V_{CES}	1200	V
Continuous DC collector current 集电极连续直流电流		$I_{C\text{ nom}}$	40	A
	$T_C=80^{\circ}\text{C}, T_{vj\text{ max}}=150^{\circ}\text{C}$	I_C	50	A
Repetitive Peak collector current 集电极可重复峰值电流	$I_{CRM}=2 \times I_{C\text{ nom}}$	I_{CRM}	80	A
Total power dissipation 总功率损耗	$T_C=25^{\circ}\text{C}, T_{vj\text{ max}}=150^{\circ}\text{C}$	P_{tot}	250	W
Gate-emitter peak voltage 门极-发射极峰值电压		V_{GES}	± 20	V

Characteristic Values / 性能参数

			min.	typ.	max.		
Collector-emitter saturation Voltage 集电极-发射极饱和压降	$I_C=40\text{A}, V_{GE}=15\text{V}$	$T_{vj}=25^{\circ}\text{C}$	$V_{CE\text{ sat}}$	2.00	2.50	V	
	$I_C=40\text{A}, V_{GE}=15\text{V}$	$T_{vj}=125^{\circ}\text{C}$		2.40			
	$I_C=40\text{A}, V_{GE}=15\text{V}$	$T_{vj}=150^{\circ}\text{C}$		2.50			
Gate Threshold Voltage 门极阈值电压	$V_{CE}=V_{GE}, I_C=1\text{mA},$	$T_{vj}=25^{\circ}\text{C}$	$V_{GE\text{ th}}$	4.50	5.80	6.50	V
Gate Charge 门极电荷	$V_{GE}= -15\text{V} \dots +15\text{V}$		Q_G	180			nC
Input Capacitance 输入电容	$V_{CE}=25\text{V}, V_{GE}=0\text{V}$ $f=1\text{MHz}$		C_{ies}	2.82			nF
Reverse Transfer Capacitance 反向传输电容			C_{res}	0.13			nF
Collector-emitter Cutoff Current 集电极-发射极关断漏电流	$V_{CE}=1200\text{V}, V_{GE}=0\text{V},$	$T_{vj}=25^{\circ}\text{C}$	I_{CES}			1	mA
Gate-emitter Leakage Current 门极-发射极漏电流	$V_{CE}=0\text{V}, V_{GE}=\pm 20\text{V},$	$T_{vj}=25^{\circ}\text{C}$	I_{GES}			± 200	nA
Turn-on Delay Time, Inductive Load 开通延迟时间, 感性负载	$I_C=40\text{A}, V_{CE}=600\text{V}$	$T_{vj}=25^{\circ}\text{C}$	t_{don}	20		ns	
	$V_{GE}=\pm 15\text{V}$	$T_{vj}=125^{\circ}\text{C}$		22			
	$R_{G\text{ on}}=30\Omega$	$T_{vj}=150^{\circ}\text{C}$		25			
Rise Time, Inductive Load 上升时间, 感性负载	$I_C=40\text{A}, V_{CE}=600\text{V}$	$T_{vj}=25^{\circ}\text{C}$	t_r	25		ns	
	$V_{GE}=\pm 15\text{V}$	$T_{vj}=125^{\circ}\text{C}$		30			
	$R_{G\text{ on}}=30\Omega$	$T_{vj}=150^{\circ}\text{C}$		30			
Turn-off Delay Time, Inductive Load 关断延迟时间, 感性负载	$I_C=40\text{A}, V_{CE}=600\text{V}$	$T_{vj}=25^{\circ}\text{C}$	t_{doff}	110		ns	
	$V_{GE}=\pm 15\text{V}$	$T_{vj}=125^{\circ}\text{C}$		140			
	$R_{G\text{ off}}=30\Omega$	$T_{vj}=150^{\circ}\text{C}$		140			
Fall Time, Inductive Load 下降时间, 感性负载	$I_C=40\text{A}, V_{CE}=600\text{V}$	$T_{vj}=25^{\circ}\text{C}$	t_f	230		ns	
	$V_{GE}=\pm 15\text{V}$	$T_{vj}=125^{\circ}\text{C}$		330			
	$R_{G\text{ off}}=30\Omega$	$T_{vj}=150^{\circ}\text{C}$		350			
Turn-on energy loss per pulse 开通损耗	$I_C=40\text{A}, V_{CE}=600\text{V},$	$T_{vj}=25^{\circ}\text{C}$	E_{on}	3.80		mJ	
	$L_o=80\text{nH}, V_{GE}=\pm 15\text{V}$	$T_{vj}=125^{\circ}\text{C}$		4.80			
	$V_{GE}=\pm 15\text{V}, R_{G\text{ on}}=30\Omega$	$T_{vj}=150^{\circ}\text{C}$		5.20			
Turn-off energy loss per pulse 关断损耗	$I_C=40\text{A}, V_{CE}=600\text{V},$	$T_{vj}=25^{\circ}\text{C}$	E_{off}	2.00		mJ	
	$L_o=80\text{nH}, V_{GE}=\pm 15\text{V}$	$T_{vj}=125^{\circ}\text{C}$		2.80			
	$V_{GE}=\pm 15\text{V}, R_{G\text{ off}}=30\Omega$	$T_{vj}=150^{\circ}\text{C}$		3.00			

SC Data 短路耐量	$V_{CE}=600V, V_{GE}=15V/-8V,$ $T_{vj}=150^{\circ}C$	t_{psc}	10			μs
Thermal Resistance, Junction to Case 结-壳热阻	Per IGBT/单个 IGBT	R_{thJC}		0.50		K/W
Temperature under switching conditions 工作温度		$T_{vj op}$	-40		150	$^{\circ}C$

Diode, Inverter / 二极管, 逆变部分

Maximum Rated Values / 最大标称参数

Repetitive peak reverse voltage 可重复反向峰值电压	$T_{vj}=25^{\circ}C$	V_{RRM}		1200		V
Continuous DC Forward Current 可连续正向直流电流		I_F		40		A
Repetitive Peak Forward Current 可重复正向峰值电流	$I_{CRM}=2 \times I_{FRom}$	I_{FRM}		80		A

Characteristic Values / 性能参数

			min.	typ.	max.	
Forward Voltage 正向通态压降	$I_F=40A, V_{GE}=0V$ $I_F=40A, V_{GE}=0V$ $I_F=40A, V_{GE}=0V$	$T_{vj}=25^{\circ}C$ $T_{vj}=125^{\circ}C$ $T_{vj}=150^{\circ}C$	V_F		1.90 2.00 2.00	2.40 V
Peak Reverse Recovery Current 反向恢复峰值电流	$I_F=40A, V_R=600V$ $-di_F/dt=500A/us$ $V_{GE}=-15V$	$T_{vj}=25^{\circ}C$ $T_{vj}=125^{\circ}C$ $T_{vj}=150^{\circ}C$	I_{RM}		25 35 35	A
Recovery Charge 反向恢复电荷	$I_F=40A, V_R=600V$ $-di_F/dt=500A/us$ $V_{GE}=-15V$	$T_{vj}=25^{\circ}C$ $T_{vj}=125^{\circ}C$ $T_{vj}=150^{\circ}C$	Q_R		2.50 5.00 6.00	μC
Reverse Recovery Energy 反向恢复损耗	$I_F=40A, V_R=600V$ $-di_F/dt=500A/us$ $V_{GE}=-15V$	$T_{vj}=25^{\circ}C$ $T_{vj}=125^{\circ}C$ $T_{vj}=150^{\circ}C$	E_{rec}		0.40 1.10 1.30	mJ
Thermal Resistance, Junction to Case 结-壳热阻	Per Diode / 单个 Diode	R_{thJC}		0.85		K/W
Temperature under switching conditions 工作温度		$T_{vj op}$	-40		150	$^{\circ}C$

Diode, Rectifier / 二极管, 整流部分

Maximum Rated Values / 最大标称参数

Repetitive peak reverse voltage 可重复反向峰值电压	$T_{vj}=25^{\circ}C$	V_{RRM}		1800		V
Maximum RMS Forward Current Per Chip 单芯片最大正向电流有效值		I_{FRMSM}		30		A
Surge Forward Current 正向浪涌电流	$t_p=10ms, \sin 180^{\circ},$ $T_{vj}=25^{\circ}C$	I_{FSM}		360		A
I^2t Value I^2t 值	$t_p=10ms, \sin 180^{\circ},$ $T_{vj}=25^{\circ}C$	I^2t		640		A^2s

Characteristic Values / 性能参数

			min.	typ.	max.		
Forward Voltage 正向通态压降	$I_F=40A$, $I_F=40A$, $I_F=40A$,	$T_{vj}=25^{\circ}C$ $T_{vj}=125^{\circ}C$ $T_{vj}=150^{\circ}C$	V_F		1.15 1.10 1.10		V
Reverse Current 反向漏电流	$V_{RRM}=1800V$,	$T_{vj}=25^{\circ}C$	I_{RM}			1	mA
Thermal Resistance, Junction to Case 结-壳热阻			R_{thJC}		0.64		K/W
Temperature under switching conditions 工作温度			$T_{vj\ op}$	-40		150	$^{\circ}C$

**IGBT, Brake-Choppe / IGBT , 制动-斩波器
Maximum Rated Values / 最大标称参数**

Collector-emitter Voltage 集电极-发射极电压	$T_{vj}=25^{\circ}C$	V_{CES}	1200	V
Continuous DC collector current 集电极连续直流电流		$I_{c\ nom}$	15	A
	$T_C=80^{\circ}C$, $T_{vj\ max}=150^{\circ}C$	I_c	28	A
Repetitive Peak collector current 集电极可重复峰值电流	$I_{CRM}=2 \times I_{c\ nom}$	I_{CRM}	30	A
Total power dissipation 总功率损耗	$T_C=25^{\circ}C$, $T_{vj\ max}=150^{\circ}C$	P_{tot}	105	W
Gate-emitter peak voltage 门极-发射极峰值电压		V_{GES}	± 20	V

Characteristic Values / 性能参数

			min.	typ.	max.		
Collector-emitter saturation Voltage 集电极-发射极饱和压降	$I_c=15A$, $V_{GE}=15V$ $I_c=15A$, $V_{GE}=15V$ $I_c=15A$, $V_{GE}=15V$	$T_{vj}=25^{\circ}C$ $T_{vj}=125^{\circ}C$ $T_{vj}=150^{\circ}C$	V_{CESat}		2.00 2.40 2.50	2.50	V
Gate Threshold Voltage 门极阈值电压	$V_{CE}=V_{GE}$, $I_c=1mA$,	$T_{vj}=25^{\circ}C$	V_{Geth}	4.50	5.80	6.50	V
Gate Charge 门极电荷	$V_{GE}= -15V \dots +15V$		Q_G		70		nC
Input Capacitance 输入电容	$V_{CE}=25V$, $V_{GE}=0V$ $f=1MHz$		C_{ies}		1.12		nF
Reverse Transfer Capacitance 反向传输电容			C_{res}		0.05		nF
Collector-emitter Cutoff Current 集电极-发射极关断漏电流	$V_{CE}=1200V$, $V_{GE}=0V$,	$T_{vj}=25^{\circ}C$	I_{CES}			1	mA
Gate-emitter Leakage Current 门极-发射极漏电流	$V_{CE}=0V$, $V_{GE}=\pm 20V$,	$T_{vj}=25^{\circ}C$	I_{GES}			± 200	nA
Turn-on Delay Time, Inductive Load 开通延迟时间, 感性负载	$I_c=15A$, $V_{CE}=600V$ $V_{GE}=\pm 15V$ $R_{Gon}=30\Omega$	$T_{vj}=25^{\circ}C$ $T_{vj}=125^{\circ}C$ $T_{vj}=150^{\circ}C$	t_{don}		14 14 15		ns
Rise Time, Inductive Load 上升时间, 感性负载	$I_c=15A$, $V_{CE}=600V$ $V_{GE}=\pm 15V$ $R_{Gon}=30\Omega$	$T_{vj}=25^{\circ}C$ $T_{vj}=125^{\circ}C$ $T_{vj}=150^{\circ}C$	t_r		20 20 21		ns

Turn-off Delay Time, Inductive Load 关断延迟时间, 感性负载	$I_C=15A, V_{CE}=600V$ $V_{GE}=\pm 15V$ $R_{Goff}=30\Omega$	$T_{vj}=25^\circ C$ $T_{vj}=125^\circ C$ $T_{vj}=150^\circ C$	t_{doff}		85 100 105		ns
Fall Time, Inductive Load 下降时间, 感性负载	$I_C=15A, V_{CE}=600V$ $V_{GE}=\pm 15V$ $R_{Goff}=30\Omega$	$T_{vj}=25^\circ C$ $T_{vj}=125^\circ C$ $T_{vj}=150^\circ C$	t_f		265 300 310		ns
Turn-on energy loss per pulse 开通损耗	$I_C=15A, V_{CE}=600V,$ $L_o=80nH, V_{GE}=\pm 15V$ $V_{GE}=\pm 15V, R_{Gon}=30\Omega$	$T_{vj}=25^\circ C$ $T_{vj}=125^\circ C$ $T_{vj}=150^\circ C$	E_{on}		1.70 2.15 2.30		mJ
Turn-off energy loss per pulse 关断损耗	$I_C=15A, V_{CE}=600V,$ $L_o=80nH, V_{GE}=\pm 15V$ $V_{GE}=\pm 15V, R_{Goff}=30\Omega$	$T_{vj}=25^\circ C$ $T_{vj}=125^\circ C$ $T_{vj}=150^\circ C$	E_{off}		0.60 0.90 1.05		mJ
SC Data 短路耐量	$V_{CE}=600V, V_{GE}=15V/-8V,$ $T_{vj}=150^\circ C$		t_{psc}	10			μs
Thermal Resistance, Junction to Case 结-壳热阻	Per IGBT/单个 IGBT		R_{thJC}		1.20		K/W
Temperature under switching conditions 工作温度			$T_{vj op}$	-40		150	$^\circ C$

Diode, Brake-Chopper / 二极管, 制动-斩波器 Maximum Rated Values / 最大标称参数

Repetitive peak reverse voltage 可重复反向峰值电压	$T_{vj}=25^\circ C$	V_{RRM}	1200	V
Continuous DC Forward Current 可连续正向直流电流		I_F	15	A
Repetitive Peak Forward Current 可重复正向峰值电流	$I_{CRM}=2 \times I_{Fnom}$	I_{FRM}	30	A

Characteristic Values / 性能参数

			min.	typ.	max.	
Forward Voltage 正向通态压降	$I_F=15A, V_{GE}=0V$ $I_F=15A, V_{GE}=0V$ $I_F=15A, V_{GE}=0V$	$T_{vj}=25^\circ C$ $T_{vj}=125^\circ C$ $T_{vj}=150^\circ C$	V_F	1.90 1.90 1.90	2.30	V
Peak Reverse Recovery Current 反向恢复峰值电流	$I_F=15A, V_R=600V$ $-di_f/dt=530A/\mu s$ $V_{GE}=-15V$	$T_{vj}=25^\circ C$ $T_{vj}=125^\circ C$ $T_{vj}=150^\circ C$	I_{RM}	11 15 25		A
Recovery Charge 反向恢复电荷	$I_F=15A, V_R=600V$ $-di_f/dt=530A/\mu s$ $V_{GE}=-15V$	$T_{vj}=25^\circ C$ $T_{vj}=125^\circ C$ $T_{vj}=150^\circ C$	Q_R	1.10 1.80 2.40		μC
Reverse Recovery Energy 反向恢复损耗	$I_F=15A, V_R=600V$ $-di_f/dt=530A/\mu s$ $V_{GE}=-15V$	$T_{vj}=25^\circ C$ $T_{vj}=125^\circ C$ $T_{vj}=150^\circ C$	E_{rec}	0.30 0.45 0.50		mJ
Thermal Resistance, Junction to Case 结-壳热阻	Per Diode / 单个 Diode		R_{thJC}	1.35		K/W
Temperature under switching conditions 工作温度			$T_{vj op}$	-40	150	$^\circ C$

NTC-Thermistor/ NTC-热敏电阻
Characteristic Values / 性能参数

			min.	typ.	max.	
Rated Resistance 标称电阻	$T_{NTC}=25^{\circ}C$	R_{25}		5		$K\Omega$
Deviation of R100 R100 偏移值	$T_{NTC}=100^{\circ}C, R_{100}=465\Omega$	$\Delta R/R$	-7.3		7.3	%
Power Dissipation 功率耗散	$T_{NTC}=25^{\circ}C$	P_{25}		50		mW
B-Value B 值	$R_2=R_{25} \exp[B_{25/50}(1/T_2-1/(298.15K))]$	$B_{25/50}$		3380		K
B-Value B 值	$R_2=R_{25} \exp[B_{25/80}(1/T_2-1/(298.15K))]$	$B_{25/80}$		3440		K

Module / 模块

Isolation Test Voltage 绝缘测试电压	RMS, f=50Hz, t=1min	V_{ISOL}		2.5		KV
Material of module baseplate 模块基板材料				Cu		
Internal Isolation 内部绝缘	基本绝缘 (class 1, IEC 61140) Basic insulation (class1, IEC 61140)			Al_2O_3		
Creepage Distance 爬电距离	端子-散热片 terminal to heatsink 端子-端子 terminal to terminal			10.0		mm
Clearance 电气间隙	端子-散热片 terminal to heatsink 端子-端子 terminal to terminal			7.5		mm
Comparative Tracking Index 相对漏电起痕指数		CTI		>225		

			min.	typ.	max.	
Thermal resistance case to heatsink 外壳 - 散热器热阻	每个模块/per module $\lambda_{Paste} = 1W/(m \cdot K) / \lambda_{grease} = 1W/(m \cdot K)$	R_{thCH}		0,02		K/W
Stray Inductance Module 模块杂散电感		L_{sCE}		60		nH
Module Lead Resistance, Terminals-Chip 模块引脚电阻, 端子-芯片	$T_c = 25^{\circ}C$, 每个开关 per switch	R_{CC+EE} $R_{AA'+CC}$		4.00 3.00		$m\Omega$
Storage Temperature 贮存温度		T_{stg}	-40		125	$^{\circ}C$
Mounting torque for modul mounting 模块安装的安装扭距	M5	M	3.00		6.00	N
Weight 重量		G		180		g

输出特性 IGBT, 逆变器(典型值)

Output characteristic IGBT Inverter (typical)

$I_C = f(V_{CE})$,

$V_{GE} = 15V$

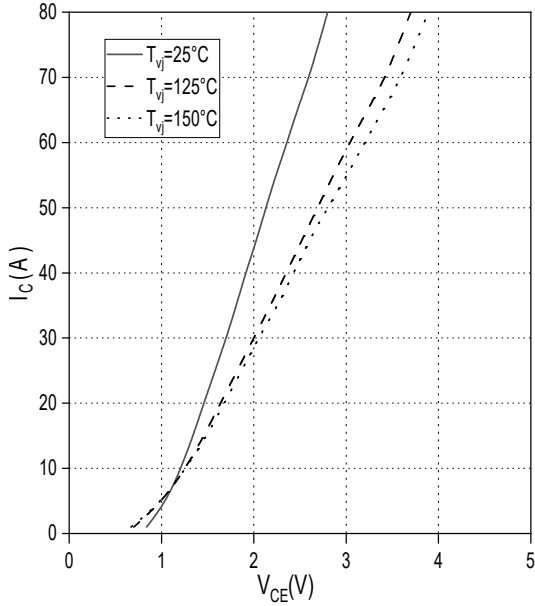

输出特性 IGBT, 逆变器(典型值)

Output characteristic IGBT Inverter (typical)

$I_C = f(V_{CE})$,

$T_{vj} = 150^\circ C$

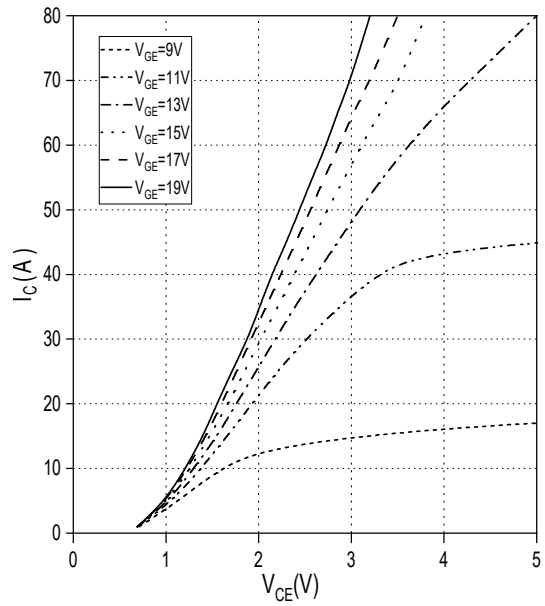

传输特性 IGBT, 逆变器 (典型值)

Transfer characteristic IGBT, Inverter (typical)

$I_C = f(V_{GE})$,

$V_{CE} = 20V$

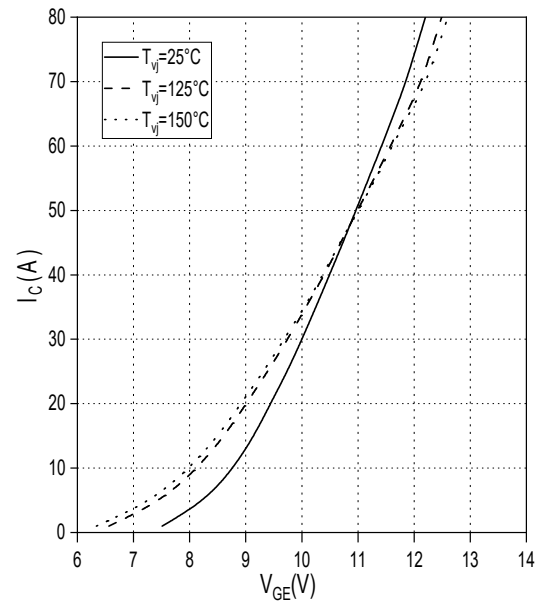

开关损耗 IGBT, 逆变器 (典型值)

switching losses IGBT, Inverter (typical)

$E_{on} = f(I_C), E_{off} = f(I_C), V_{GE} = \pm 15V$,

$R_{Gon} = 30\Omega, R_{Goff} = 30\Omega, V_{CE} = 600V$

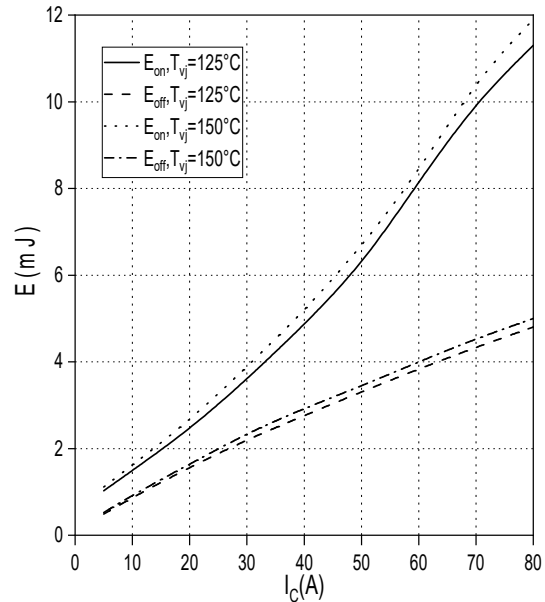

开关损耗 IGBT, 逆变器 (典型值)

Switching losses IGBT, Inverter (typical)

$V_{GE} = \pm 15V, I_C = 40A, V_{CE} = 600V$

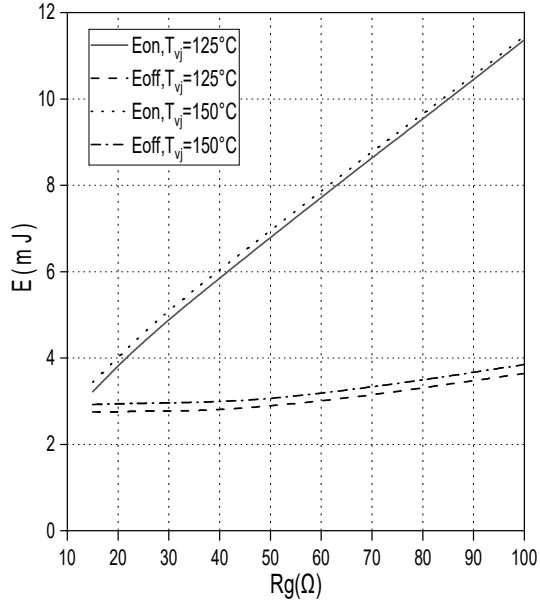

瞬态热阻抗 IGBT, 逆变器

transient thermal impedance IGBT, Inverter

$Z_{thJC} = f(t)$

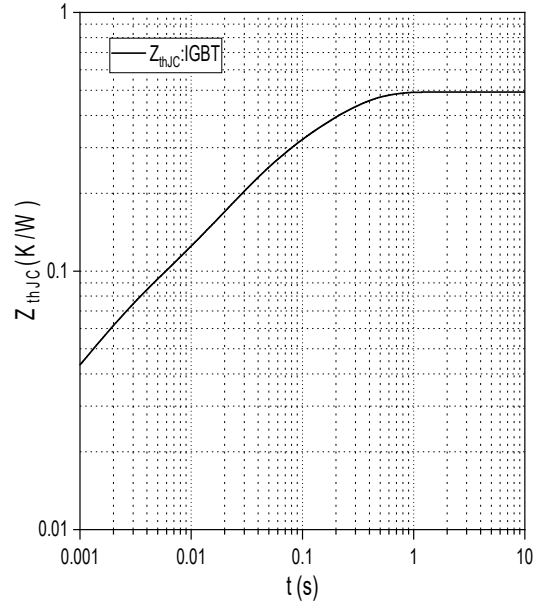

反偏安全工作区 IGBT, 逆变器(RBSOA)

Reverse bias safe operating area IGBT, Inverter (RBSOA) $I_C = f(V_{CE})$,

$V_{GE} = \pm 15V, R_{Goff} = 30\Omega, T_{vj} = 150^\circ C$

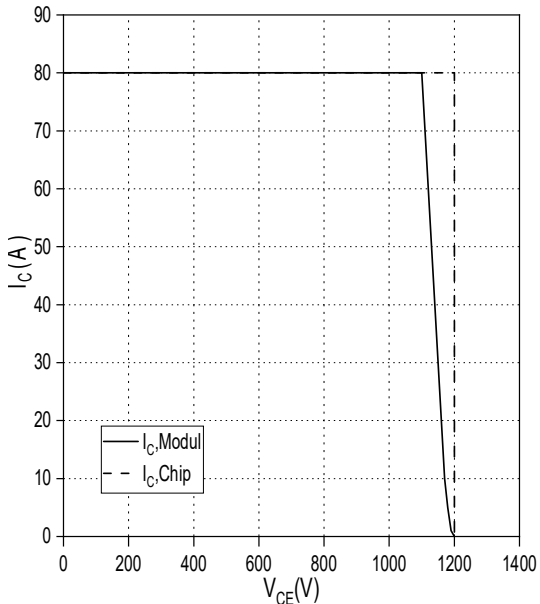

正向偏压特性二极管, 逆变器 (典型值)

forward characteristic of Diode, Inverter (typical)

$I_F = f(V_F)$

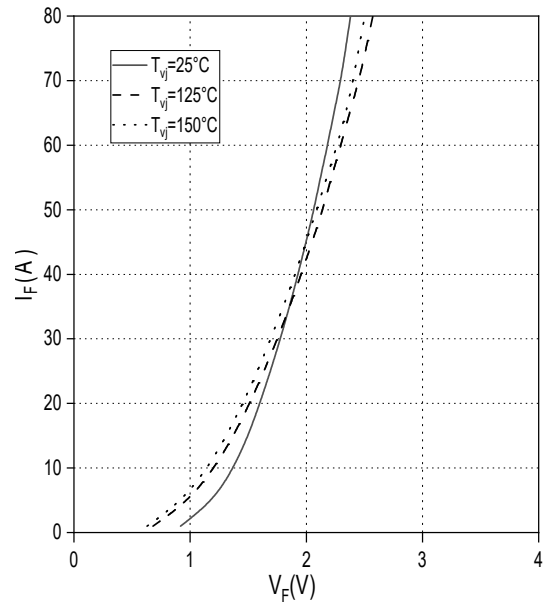

开关损耗二极管,逆变器 开关损耗 (典型值)
Switching losses Diode, Inverter (typical)

$E_{rec} = f(I_F)$
 $R_{Gon} = 30\Omega, V_{CE} = 600V$

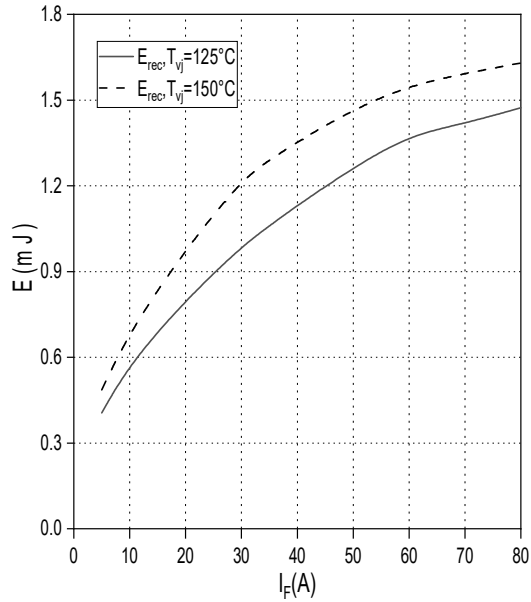

二极管,逆变器 (典型值)

Switching losses Diode, Inverter (typical)

$E_{rec} = f(R_G)$
 $I_F = 40A, V_{CE} = 600V$

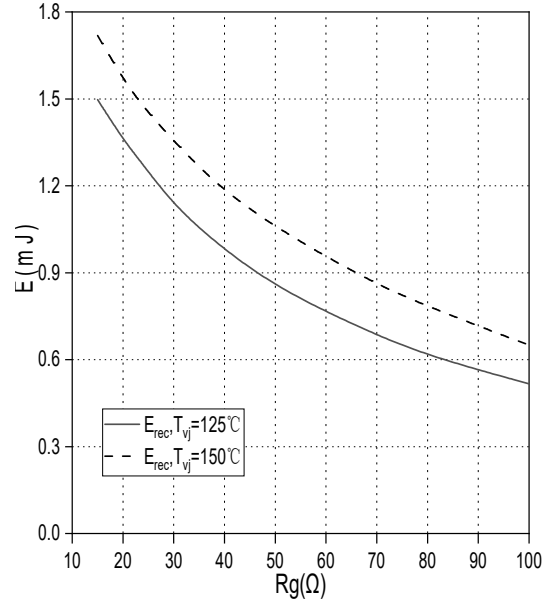

瞬态热阻抗二极管,逆变器
transient thermal impedance Diode, Inverter

$Z_{thJC} = f(t)$

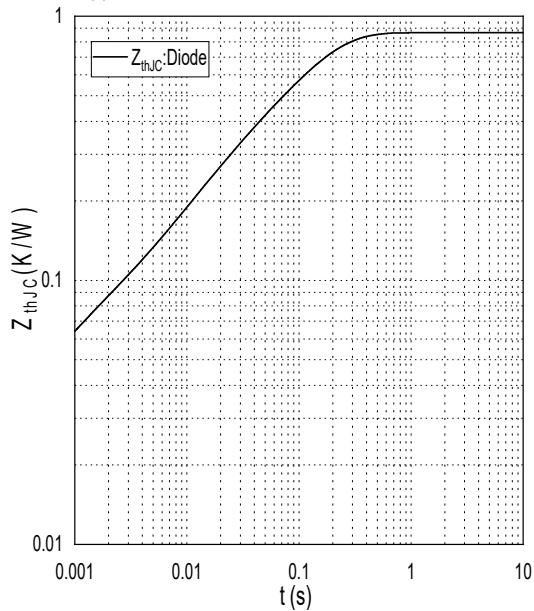

正向偏压特性 二极管,整流器 (典型值)
forward characteristic of Diode Rectifier (typical)

$I_F = f(V_F)$

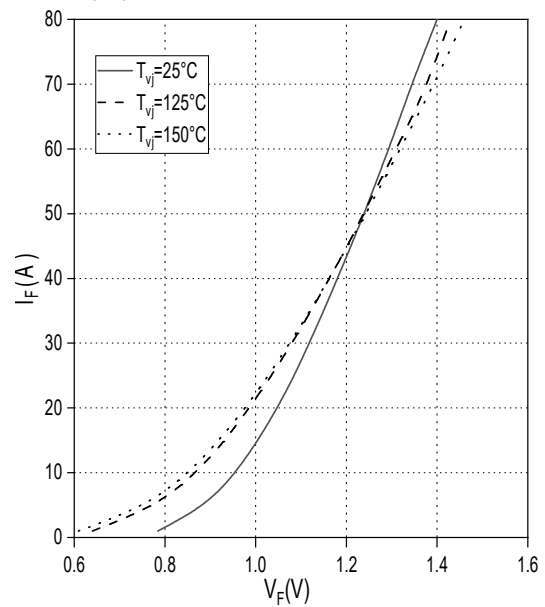

输出特性 IGBT, 制动-斩波器 (典型值)

Output characteristic IGBT, Brake-Chopper (typical)

$I_C = f(V_{CE})$

$V_{GE} = 15V$

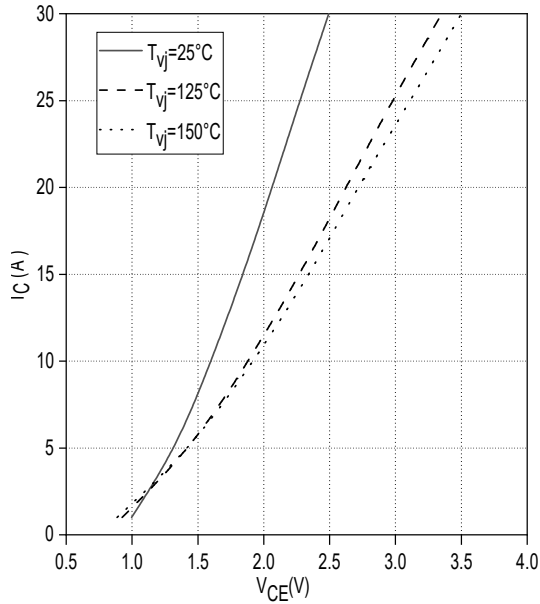

正向偏压特性 二极管, 制动-斩波器 (典型值)

forward characteristic of Diode, Brake-Chopper (typical)

$I_F = f(V_F)$

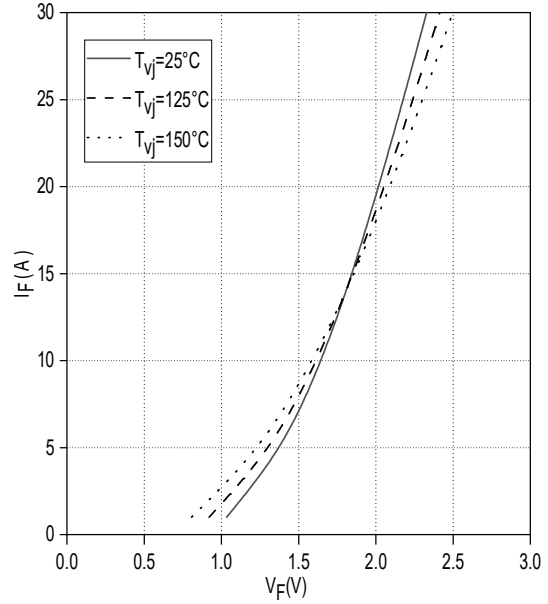

负温度系数热敏电阻 温度特性 (典型值)

NTC-Thermistor-temperature characteristic (typical)

$R = f(T)$

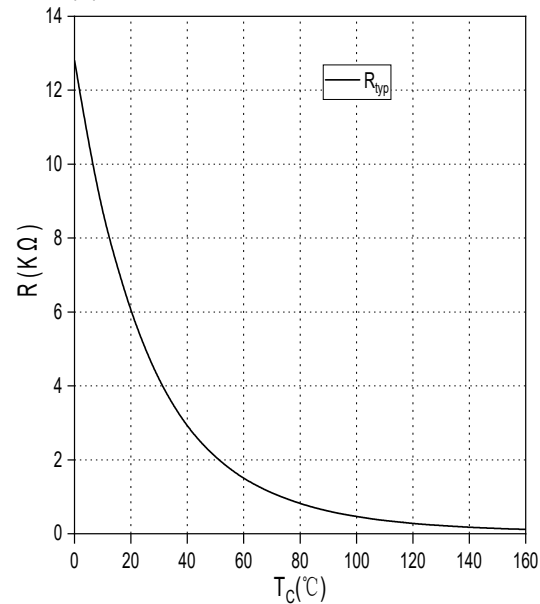

Internal Circuit:

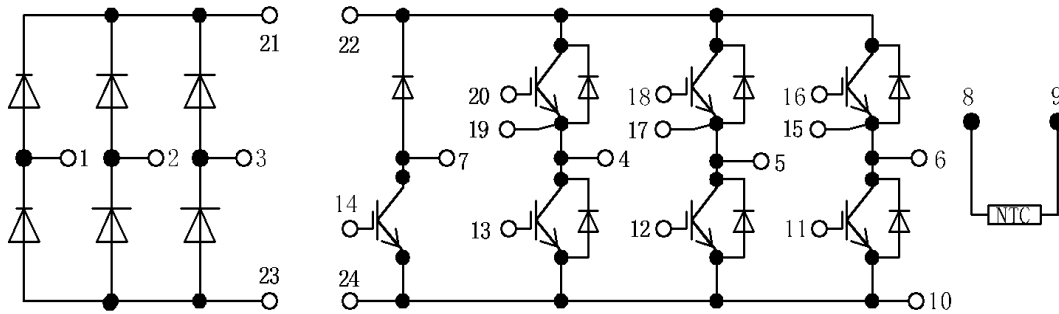

**Package Dimension
Dimensions in Millimeters**

